

Part number: **SIP000276** Model: **SIP12-NE4 LC5**

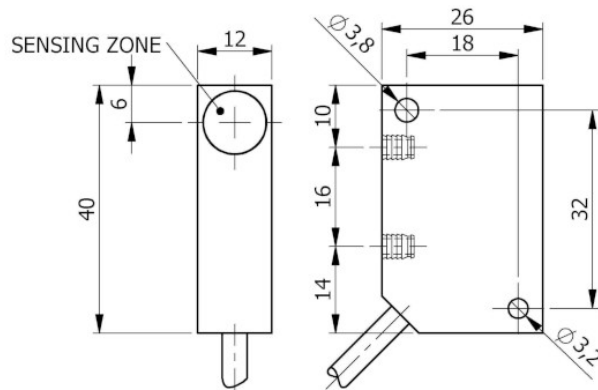

Dimension in mm

1. TECHNICAL CHARACTERISTICS



Electrical data

Power supply type:		Direct current
Working voltage:	[V]	5 ÷ 30
Current consumption:	[mA]	On <= 1 mA - Off >= 3 mA @ 8.2V
Protection class:		III
Reverse polarity protection:		Presente

Outputs

Electrical design:		Namur
Max switching frequency:	[Hz]	2000

Detection zone

Switching distance-Sn:	[mm]	4
Real sensing distance-Sr:	[mm]	4 ±10%
Operative distance-So:	[mm]	0 ÷ 3.24

Accuracy and Deviations

Correction factor:		Stainless steel: 0.9 - Brass: 0.5 - Aluminium: 0.4 - Copper: 0.4
Switching point drift:	[%Sr]	-1
Repeatability:	[%Sn]	< 3

Environmental conditions

Temperature limits:	[°C]	-25/+70
IP rating:		IP65-IP66-IP67

Mechanical data

Housing:		Parallelepiped
Dimensions:	[mm]	12 x 40 x 26
Materials:		Housing: PVC black - Sensing area: PC red
Mounting:		Not embeddable
Weight:	[g]	140

Electrical connection

Cable: 5 m - PVC/PVC -2 x 0.25 mm²

Compliance to Standards / Directives

Directives compliance: 2014/30/EU -Electromagnetic compatibility directive (EMC)

Standards compliance: EN60947-5-6 - Product standard

2. NORME DI INSTALLAZIONE

WIRING DIAGRAM

2 WIRES CABLE

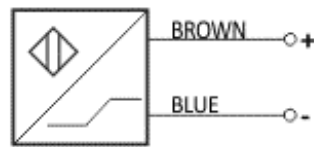

INSTRUCTIONS FOR CORRECT INSTALLATION

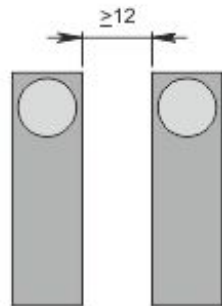

Side by side mounting

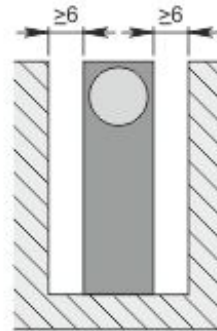

Flush mounting

Titolo img 1

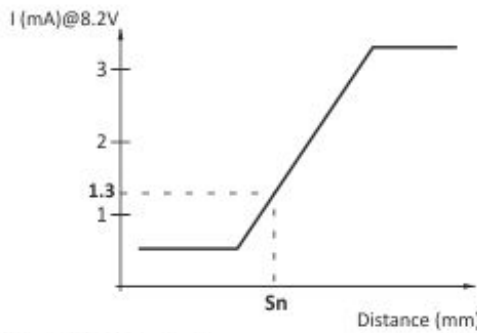

The NAMUR inductive sensors are electronic devices whose absorbed current varies in the presence of a metallic target.

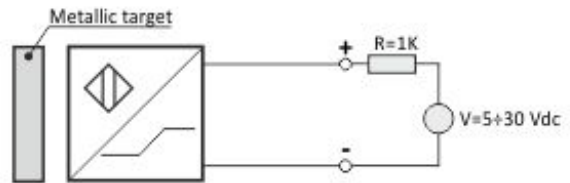

In presence of metallic target $I \leq 1\text{mA}@8.2\text{V}$

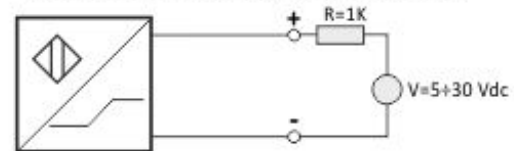

In absence of metallic target $I \geq 3\text{mA}@8.2\text{V}$