



Part number: YRL000008 - Model: RL-A 48 Vac



TECHNICAL CHARACTERISTICS

Power supply:	Alternating current
Working voltage:	48Vac
Function:	Changeover relay
Housing material:	Grey plastic PA6
Sensitivity:	adjustable to 3 positions
Absorption:	4 VA
Max. output current:	2A @ 300Vdc / 2A @ 250Vac
Process temperature:	-20 ÷ +80 °C
Ambient temperature:	-20 ÷ +60 °C
IP rating:	IP 6X
Max. tank pressure:	-0.2 ÷ +0.1 bar
Threaded fixing:	1 1/2 inch GAS - PA6 GF30 black plastic
Rotation speed paddle:	1 RPM
Weight:	700 g
Explosive atmosphere type:	Air-Dust Mixture
Equipment category:	1/2D
Installation area:	Zone 21 and Zone 22
Protection method:	Enclosure ' t '
Marking:	II 1/2D Ex t IIIC T120°C Da/Db IP6X
Conforming standard:	EN60079-0 e EN60079-31
EC-tipe examination certificate - ATEX:	BVS 06 ATEX E 044



Part number: YRL000008 - Model: RL-A 48 Vac

WIRING DIAGRAM

NORME DI INSTALLAZIONE / *Instructions for installation*

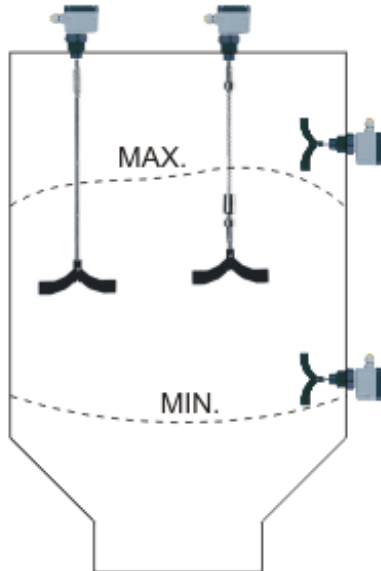

L'apparecchio viene applicato sulla parete esterna del contenitore lateralmente o dall'alto, mediante attacco filettato 1 1/2" GAS.

Il materiale deve potersi muovere liberamente attorno all'elica che non deve essere investita dal getto diretto del materiale. Per evitare questo inconveniente predisporre eventuali deflettori di protezione sopra il segnalatore quando il peso sull'elica e relativo albero è elevato (materiale ad alto peso specifico o soggetto a movimenti in blocco).

The unit is placed on the external wall of the container mounted it by means of a standard fixing 1 1/2" GAS. The material must be able to move freely around the paddle and this must not be installed in the jet of material.

In order to avoid this it may be necessary to install deflectors above the unit when the mass of the material is high.

INSTRUCTIONS FOR CORRECT INSTALLATION

CONSIGLI PER IL MONTAGGIO / *Suggestion for mounting*

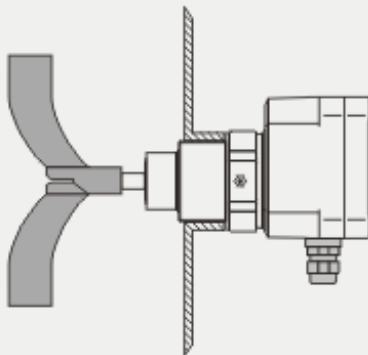

A : Fissare la vite dopo aver effettuato la procedura B.
Fix the screw after procedure B.

B : Montaggio corretto. Il pressacavo deve essere rivolto verso il basso.
For a correct mounting the cable gland must be facing downwards.

C : Per facilitare l'entrata dell' elica nel foro di fissaggio tagliare un' aletta.
To facilitate entrance of paddle in the fixing hole pls. cut a paddle.

ISTRUZIONI PER L'USO / Operating instruction

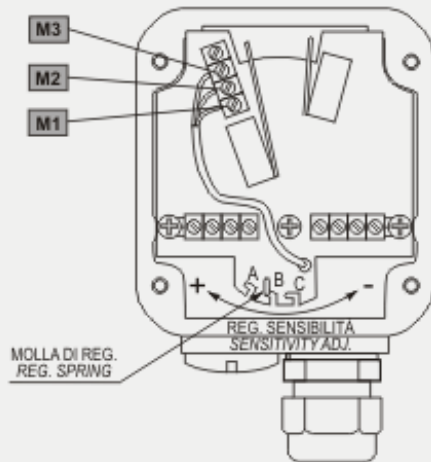

ALIMENTAZIONE Supply voltage	M1	M2	M3
24 Vdc	rosso / red	marrone / brown	blu / blue
24 Vac (*)	rosso / red	marrone / brown	blu / blue
48 Vac	rosso / red	blu / blue	marrone / brown
110 Vac (*)	rosso / red	marrone / brown	blu / blue
220 Vac	rosso / red	blu / blue	marrone / brown

(*) Collegamenti pre-impostati / Pre-set connection

La molla di regolazione della forza di rotazione è regolabile in 3 posizioni :
The power rotation regulation spring can be adjusted as follows :

A = debole / weak
B = media / average
C = dura / hard

SCHEMI DI COLLEGAMENTO / WIRING DIAGRAMS

TENSIONE DI ALIMENTAZIONE C.A.
SUPPLY VOLTAGE A.C.

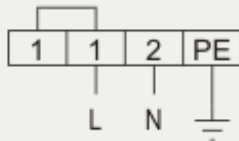

CONTATTO DI USCITA
OUTPUT CONTACT

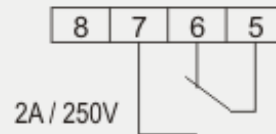

N.B. : Il contatto è rappresentato con apparecchiatura sotto tensione ed elica in movimento
The contact is ON when the device is under tension and the paddle moving