

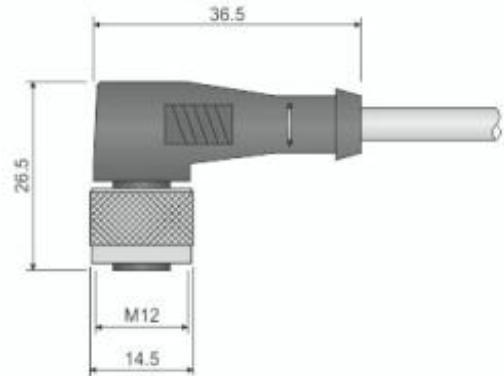

Part number: COC000019 - Model: MOD.14/4 M12 SL LC5

Connettore femmina M12 - versione 90°
M12 female connector - 90° type



Configurazione e colori - vista lato frontale
Configuration and wires color - front view

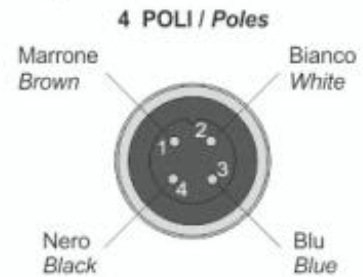

Dimension in mm

TECHNICAL CHARACTERISTICS

Connection type:	M12X1
Configuration:	FEMAL
Number of poles:	4
Cable length:	5mt
Cable jacket material:	PVC CEI20/22 II
Cable insulation material:	PVC
Cable jacket colour:	GREY
Cable jacket diameter:	4.80 +/-0.1
Cable insulation colour:	BROWN/BLUE/BLACK/WHITE
Cable conductors material:	COPPER TINNED CLASS 6
Cable conductor section:	0.25 mmq
Nut fixing material:	NICKELLED BRASS
Plug material:	ABS V0 SELF EXTINGUISHING
Pole material:	PHOSPHOR BRONZE
Pole treatment:	GOLDEN
Rated current:	4A
Rated voltage:	250Vac/dc
IP rating:	IP67

Operating temperature:

-10° ÷ +80°C



MORE THAN SENSORS

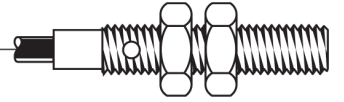

Part number: COC000019 - Model: MOD.14/4 M12 SL LC5

