

Part number: **SIA000244** Model: **SIA44-NE LC10**

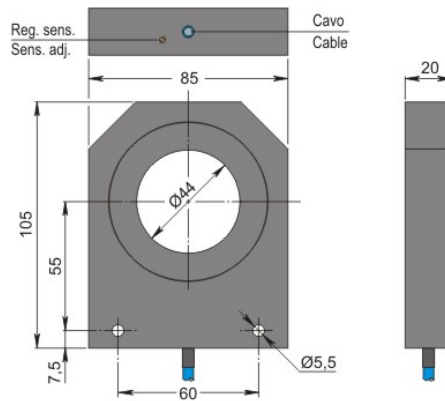

Dimension in mm

## 1. TECHNICAL CHARACTERISTICS



### Electrical data

Power supply type:		Direct current
Working voltage:	[V]	5 ÷ 30
Current consumption:	[mA]	On <= 1 mA - Off >= 3 mA @ 8.2V
Protection class:		III
Reverse polarity protection:		Presente

### Outputs

Electrical design:		Namur
Max switching frequency:	[Hz]	250 ÷ 600

### Detection zone

Sensing hole diameter:	[mm]	44
Minimum detectable object:	[mm]	$\varnothing 5 \times 9$ - Fe360

### Accuracy and Deviations

Correction factor:		Stainless steel: 0.9 - Brass: 0.5 - Aluminium: 0.4 - Copper: 0.4
Hysteresis:	[%Sr]	Depends on the sensitivity
Switching point drift:	[%Sr]	-1
Repeatability:	[%Sn]	< 0.3

### Environmental conditions

Temperature limits:	[°C]	-20 / +60 °C
IP rating:		IP65

### Mechanical data

Housing:		Ring
Dimensions:	[Hz]	85 x 20 x 105
Materials:		Housing: PVC black - Sensing area: PVC black
Mounting:		Not embeddable
Weight:	[g]	500

#### Electrical connection

Cable: 10 m - PVC/PVC - 2 x 0.50 mm<sup>2</sup>

#### Compliance to Standards / Directives

Directives compliance: 2014/30/EU - Electromagnetic compatibility directive (EMC)

Standards compliance: EN60947-5-6 - Product standard

## 2. NORME DI INSTALLAZIONE

#### WIRING DIAGRAM

### 2 WIRES CABLE

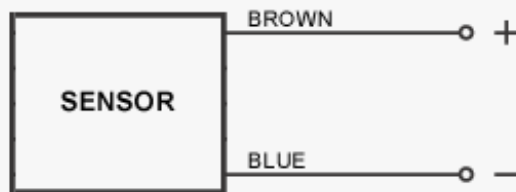

#### INSTRUCTIONS FOR CORRECT INSTALLATION

### INSTRUCTIONS FOR CORRECT INSTALLATION

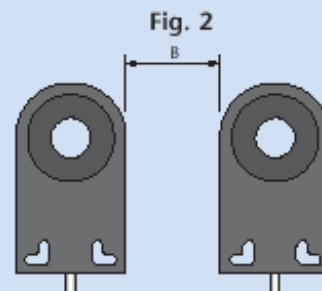
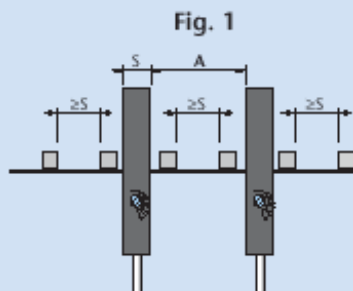

Model	SIA05	SIA12	SIA15	SIA22	SIA30	SIA44	SIA63	SIA100
A (Fig. 1) mm	25	30	30	60	60	300	300	600
B (Fig. 2) mm	10	10	10	20	20	250	250	650

Titolo img 1

### WORKING PRINCIPLE

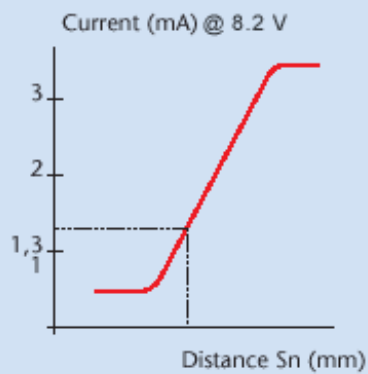

In presence of metal  $I \leq 1 \text{ mA @ } 8.2 \text{ V}$

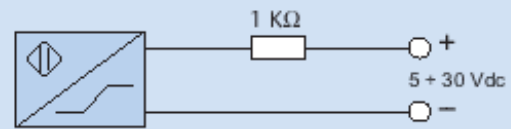

In absence of metal  $I \geq 3 \text{ mA @ } 8.2 \text{ V}$

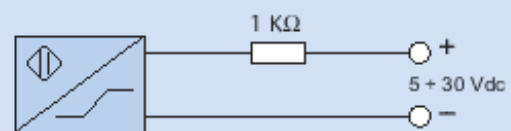

The NAMUR sensors are electronic devices whose absorbed current varies in the presence of a metallic object. The difference between these sensors and traditional sensors is the absence of amplifier trigger stages.