



Part number: C18000066 - Model: SC18SM-CE10 PNP NO+NC LC10



TECHNICAL CHARACTERISTICS

Working voltage:	10 ÷ 40 Vdc
Output type:	DC PNP
Function:	NO+NC
Actuation type:	Instantaneous
Sensing distance (mm):	0 ÷ 10 (adjustable)
Hysteresis (%Sn):	Depends on the switching distance
Max switching frequency:	10 Hz
Repeatability (%Sn):	< 10
Max output current:	200 mA
Absorption:	< = 10 mA @ 24Vdc
Voltage drop:	< 1.8 V
Short circuit protection:	Present
Led indicator:	Present
Shielding:	Not embeddable
Mechanical characteristics:	M18x1
Housing material:	Nickelled brass
Connection type:	Cable 10 m
Cable type:	4x0.25 PVC
Temperature limits:	-20 ÷ +70 °C
IP rating:	IP 67
Weight:	450 g



Part number: C18000066 - Model: SC18SM-CE10 PNP NO+NC LC10

WIRING DIAGRAM

4 WIRES CABLE - LOGIC PNP NO+NC

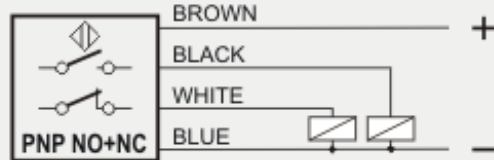

INSTRUCTIONS FOR CORRECT INSTALLATION

INSTRUCTIONS FOR CORRECT INSTALLATION

NOT EMBEDDABLE

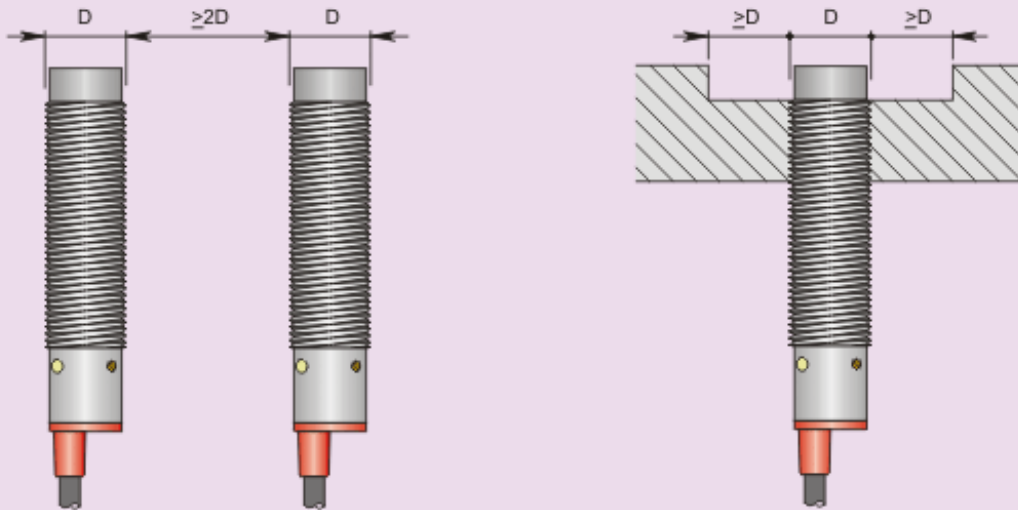

Side by side mounting

Non flush mounting